



PRODUCT CATALOGUE 2020

## WHO WE ARE...

Pritam Electricals was established in 1983. Today Pritam is a name synonymous with cutting-edge, high quality switches and electrical products in India. Situated in Kolkata, West Bengal, Pritam has been an industry leader, serving clients across India since its inception.

We have built our reputation on developing and manufacturing products of the highest quality, through precision in design and manufacturing as well as attentive quality control, in order to provide products with optimum performance and durability. We are proud of our achievements and are dedicated to delivering products of the highest standard; our products are quality assured to the international quality management system standard ISO 9001 and are produced in a state of the art manufacturing facility in SEZ of Kala Amb in Himachal Pradesh. Thanks to our strong network of distributors, our products are available in almost all parts of India.

Our vision is to get resounding success in every juncture of Pritam and our track record of longevity and success are the proof of same. Integrity and hardwork are not only our values but also the foundation. Since the inception, we have been maintaining them. Through controlled growth and staying on the forefront of industry trends, we believe that we are ideally keyed up for the brightest future.



**VIVID**

Designed specially for modern homes.

**NORAH**

**ZENN**

Perfect combination of  
**Simplicity** and **Class.**

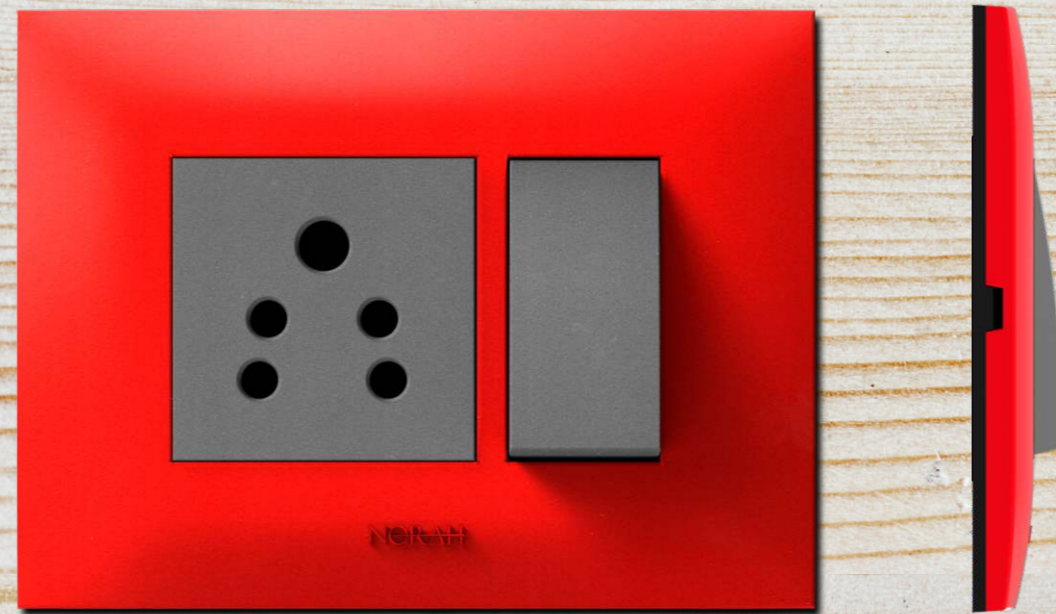

Introducing Zenn the perfect combination of style and simplicity.  
Crafted to Perfection Zenn is available in beautiful colour combinations and textures.

### Vertical and Horizontal Mounting

The design follows the formula that you must get convenience in any form you choose to work. These plates offer simplicity and ease in terms of placing them horizontally and vertically according to your personal comfort and convenience.

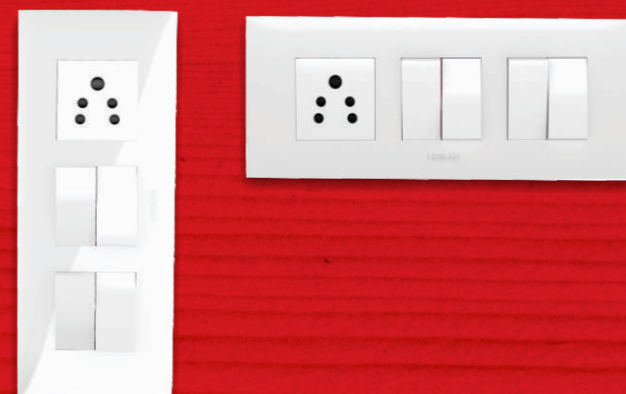



**VIVID**

Light Up  
your Spaces.



Designed specially for modern homes.  
Available in fascinating colours and beautifully  
textured glass finish polycarbonate cover.



# ***NORAHWood***

Make a Bold  
Statement.

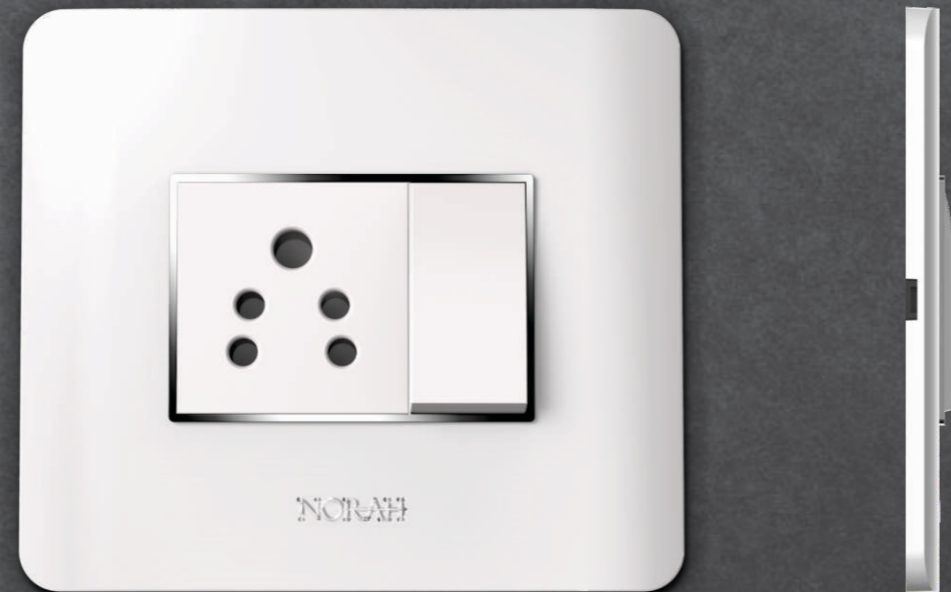

Bold & Beautiful NorahWood  
are the new additions to Norah Series.  
Soft corners, chrome finish linings and  
engineered to retro fit to all kinds of boxes.





SLEEKIO\*

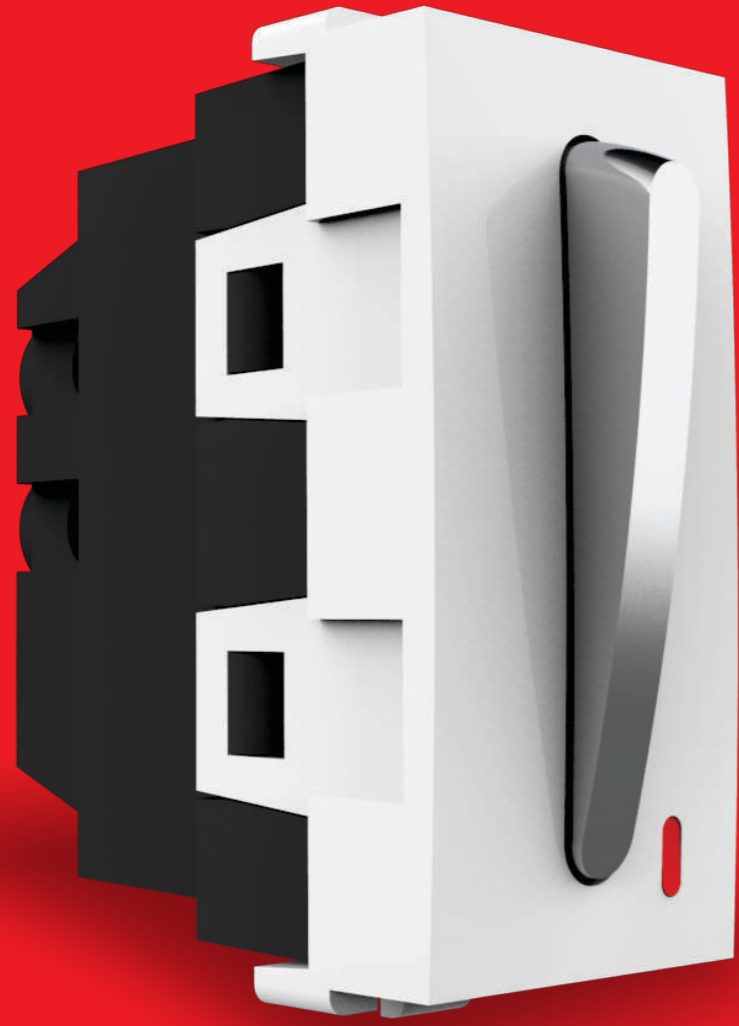

Experience  
the **Luxury**  
with the touch of  
**Chrome Metallic**



## SLEEKIO\* SWITCH

---

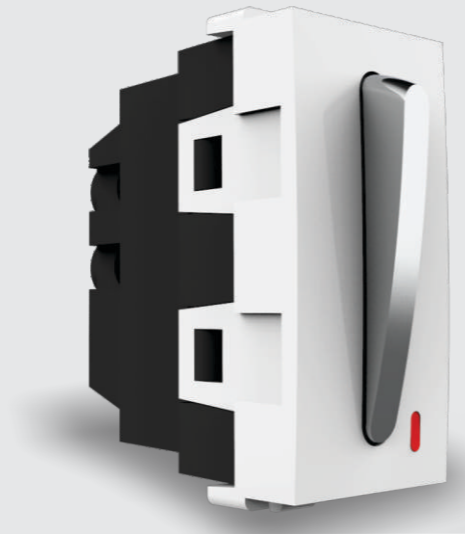

WHITE

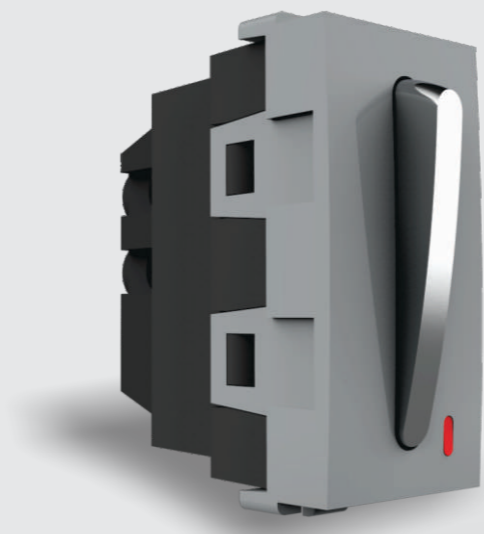

SILVER

Sleek, Elegant and Beautifully Crafted Sleekio is a Modern take on Modular Switches. Chrome plated switch and LED indicators, Sleekio is sure to adorn your beautiful walls.

## CURVIO SWITCH

---

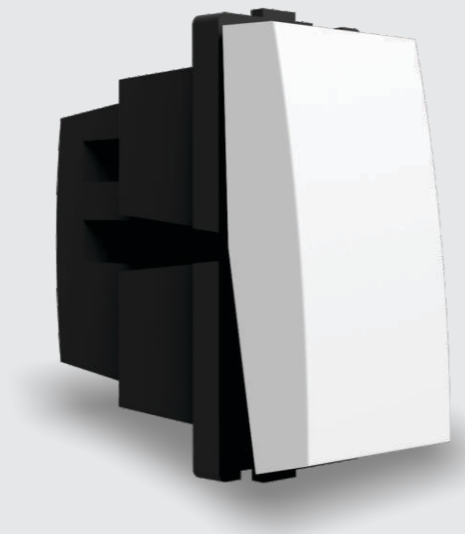

WHITE

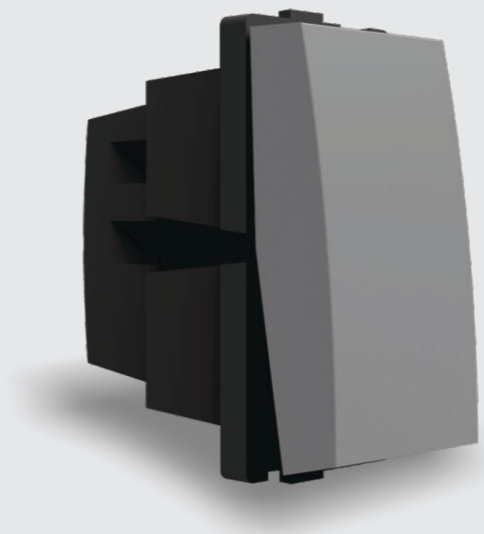

SILVER

In love with wide switches Curvio is a perfect fit for your home. Delicately crafted to perfection Curvio leaves a lasting impression.

# Switches & Accessories

NORAH

CURVIO SWITCHES (1 & 2 MODULE)	PKG.
6 A. 1 Way Switch	20
6 A. 2 Way Switch	20
6 A. Bell Push	20
16 A. 1 Way Switch	20
16 A. 1 Way Switch "with Indicator"	20
16 A. 2 Way Switch	20
<b>6 A. Bell Push "with Indicator"</b>	10
<b>30 A. D. P. Switch "with Indicator"</b>	10

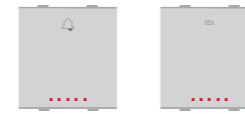
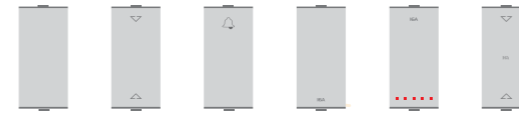

SLEEKIO SWITCHES (1 MODULE)	PKG.
6 A. 1 Way Switch	20
6 A. 2 Way Switch	20
6 A. Bell Push	20
16 A. 1 Way Switch	20
16 A. 1 Way Switch "with Indicator"	20
16 A. 2 Way Switch	20

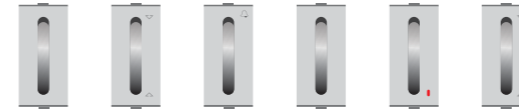

SOCKETS WITH SAFETY SHUTTER	PKG.
USB Charger (2.4 A.)	10
6 A. 2 Pin Socket	20
6 A. 2-In-One Socket	10
6 & 16 A. Universal Socket	10
13 A. International Socket	10

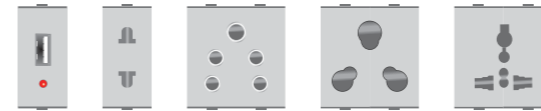

INDICATOR / FUSE / B. PLATE / T.V.Soc. / TTLE. & COMP. JACK	PKG.
6 A. Indicator	20
10 / 16 A. Fuse	20
Blank Plate	80
T.V. Socket	20
Tele. Jack (RJ 11)	20
Computer Jack Cat 6 (RJ45)	20

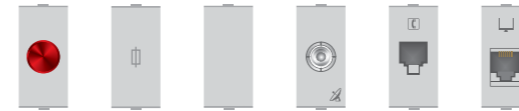

DIMMER & FAN REGULATOR	PKG.
400 W Dimmer (1m) "For Lamp Only"	10
4 Step Regulator (1m) "Full Rotary"	10
5 Step Regulator (2m) "Full Rotary"	10



MCBs & MOTOR STARTER	PKG.
MCB S.P. ( 6 / 10 / 16 / 20 / 25 / 32 Amp.)	10
MCB D.P. ( 16 / 20 / 25 / 32 Amp.)	10
Motor Starter Switch (16 / 2 / 25 Amp.)	10



LED / CUCKOO BELL / KEY TAG	QTTY.
LED Light ( Square )	10
LED Light ( Down )	10
Cuckoo Bell	10
32 A. Switch with key tag	10
Only Key Tag	10

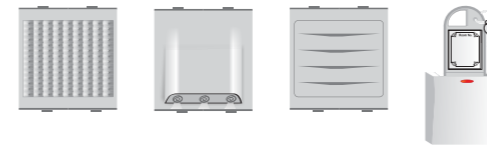

## COLOUR OPTIONS

ALL SWITCHES, SOCKETS & PERIPHERALS ARE AVAILABLE IN **WHITE** AND **SILVER**.

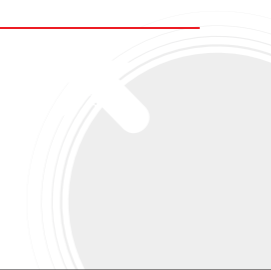

# GLASSIC

Beautiful glass finished body  
with chrome lined fine edges.



***GLASSIC***

Your First Choice in  
**Contemporary Modular  
Switches.**

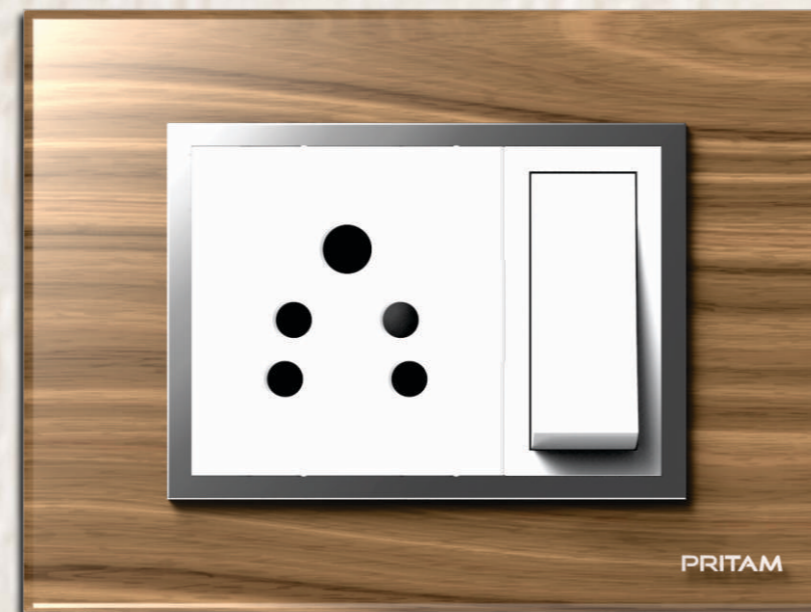

Crafted for Modern Houses...  
Glassic is the first choice for Contemporary Modular Switches.  
Beautifully crafted has a glass like effect with fine  
chrome lining on the outer edge.



**VISTA**

Perfect fit for  
Modern homes.



Switch on the classic style with Vista series.  
Simplistic Elegance with fine touch of Chrome,  
Vista Panels are a perfect fit for your Modern Homes.





***FITWOOD  
ULTRA***

**Engineered to Retro Fit  
to all types of Boxes**

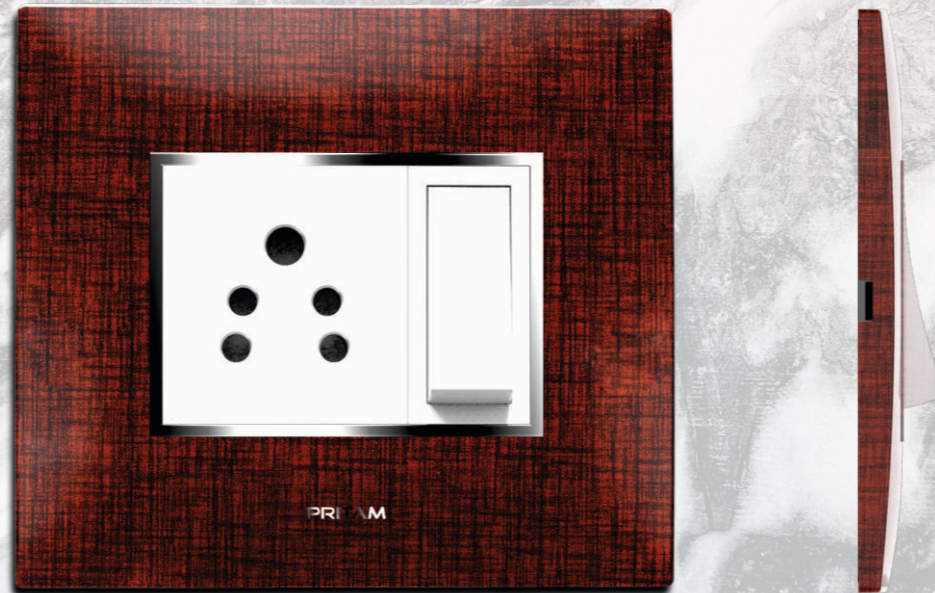

Classic and Trendy FitwoodUltra are the Contemporary Modular Switches for Homes, can be Retro Fitted to all types of boxes.



***SOLO***

The Best of  
**Simplicity**  
is here!



Solo range of switch panels  
are here to adorn your spaces.  
Available in Classic White.





For all your Style Requirements  
**Contemporary** to **Modern**  
We have got it all covered!



## CURVE SWITCH

---

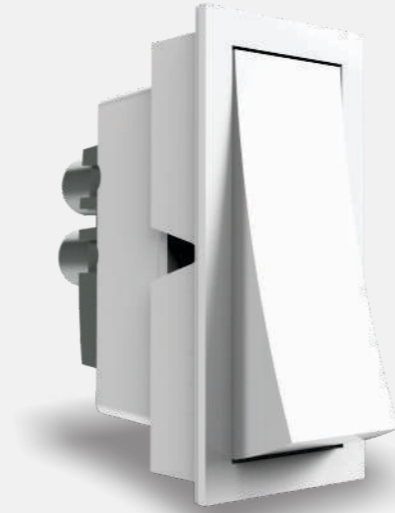

WHITE



GREY

Curve is a heavy duty modular switches with curve edge.

## Zero Degree SWITCH

---

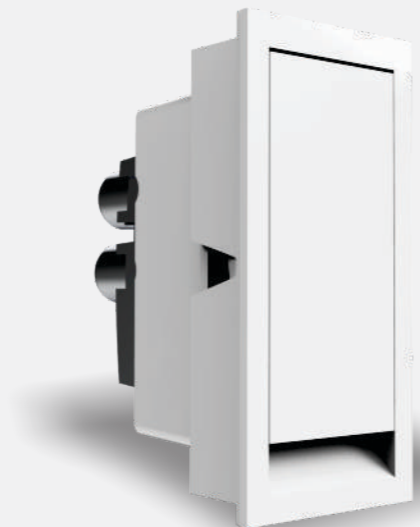

WHITE

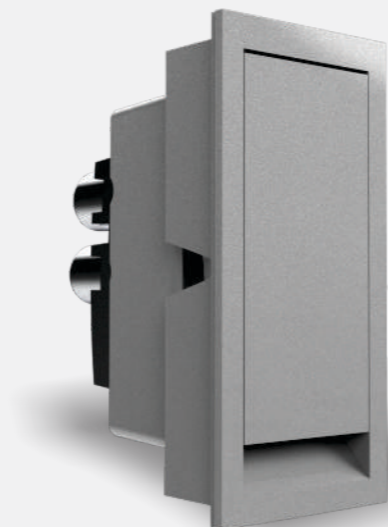

SILVER

Designed to remain flushed with the cover plate.  
Zero Degree is our take on Flat switches.  
Operates at gentle pressure.  
Zero Degree blends seamlessly in any home decor.



## Switches

CURVE SWITCHES (1 MODULE)	PKG.
6 A. 1 Way Switch	20
6 A. 2 Way Switch	20
6 A. Bell Push	20
16 A. 1 Way Switch	20
16 A. 1 Way Switch "with Indicator"	20
16 A. 2 Way Switch	20

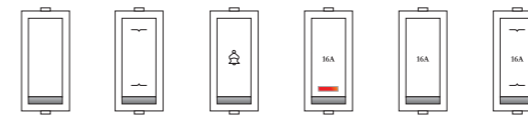

CURVE SWITCHES (2 MODULE)	PKG.
6 A. Bell Push "with Indicator"	10
16 A. 1 Way Switch	10
16 A. 1 Way Switch "with Indicator"	10
32 A. D. P. Switch "with Indicator"	10



ZERO DEGREE (1 MODULE)	PKG.
6 A. 1 Way Switch	20
6 A. 2 Way Switch	20
6 A. Bell Push	20
16 A. 1 Way Switch	20
16 A. 1 Way Switch "with Indicator"	20
16 A. 2 Way Switch	20

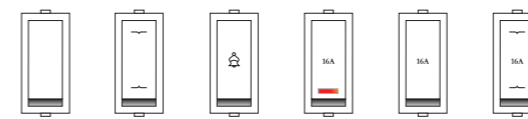

## Sockets & Peripherals

SOCKETS WITH SAFETY SHUTTER	PKG.
6 A. 2 Pin Socket	20
6 A. 2-In-One Socket	10
6 & 16 A. Universal Socket	10
13 A. International Socket	10

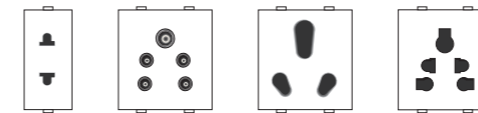

INDICATOR / FUSE / BLANK PLATE	PKG.
6 A. Indicator	20
10 / 16 A. Fuse	10
Blank Plate	100

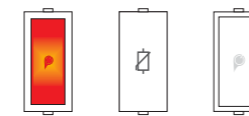

T.V. ANTENNA   TELE JACKS & CORD OUTLET	PKG.
T. V. Antenna Socket	10
2 Line Telephone Jack	10
Computer Jack	10

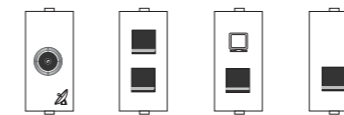

DIMMER, FAN REGULATOR & USB CHARGER	PKG.
400 W Dimmer (1M)	10
4 Step Regulator (1M) "Full Rotary"	10
5 Step Regulator (2M) "Full Rotary"	10
USB Charger (2.4 A.)	



## COLOUR OPTIONS

ALL SOCKETS & PERIPHERALS ARE AVAILABLE IN **WHITE, SILVER AND GREY.**

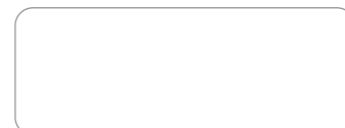



## Peripherels

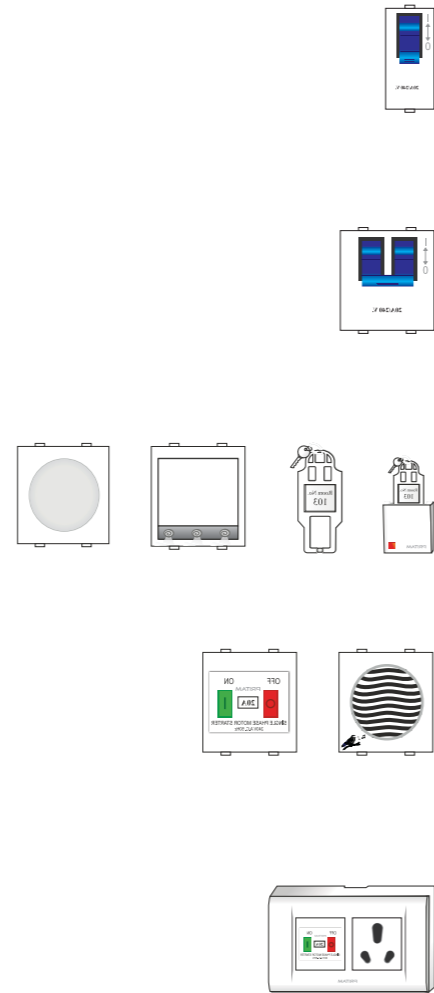

MCB (SINGLE POLE & DOUBLE POLE)	PKG.
6 A. SP MCB10	10
10 A. SP MCB10	10
16 A. SP MCB10	10
20 A. SP MCB10	10
25 A. SP MCB10	10
32 A. SP MCB	10

6 A. DP MCB10	10
10 A. DP MCB10	10
16 A. DP MCB10	10
20 A. DP MCB10	10
25 A. DP MCB10	10
32 A. DP MCB	10

DP / KEY TAG & LED LIGHT	PKG.
32 A. Switch With Key Tag	10
Key Tag (Only)	10
LED Lamp ( Down )	10
LED Lamp ( Round )	10

BUZZER! CUCKOO & MOTOR STARTER	PKG.
Electronic Buzzer	10
Cuckoo Bell	10
16 A. Motor Starter Switch	10
20 A. Motor Starter Switch	10
25 A. Motor Starter Switch	10

16A. SOCKET & STARTER COMBINED	PKG.
16 A. Combined Starter (with Box)	10
20 A. Combined Starter (with Box)	10
25 A. Combined Starter (with Box)	10

## GI Metal Box & PVC Surface Box

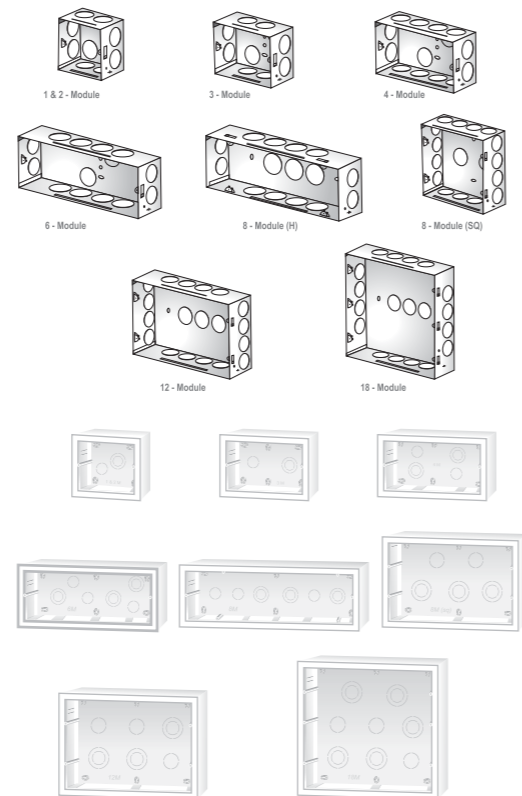

GI BOX	SIZE IN INCH	PKG.
1 & 2 Module	3 x 3	10
3 Module	4 x 3	10
4 Module	5 x 3	10
6 Module	8 x 3	10
8 Module (H)	9 x 3	10
8 Module (SQ)	5 x 5	10
12 Module	8 x 6	5
18 Module	9 x 8	5

PVC SURFACE BOX	SIZE IN INCH	PKG.
1 & 2 Module	3 x 3	10
3 Module	4 x 3	10
4 Module	5 x 3	10
6 Module	8 x 3	10
8 Module (H)	9 x 3	10
8 Module (SQ)	5 x 5	10
12 Module	8 x 6	5
18 Module	9 x 8	5

# LED

Designed with **Simplicity** and **Compactness** of Today's Technology to meet every Decor need of Home or Institutions...

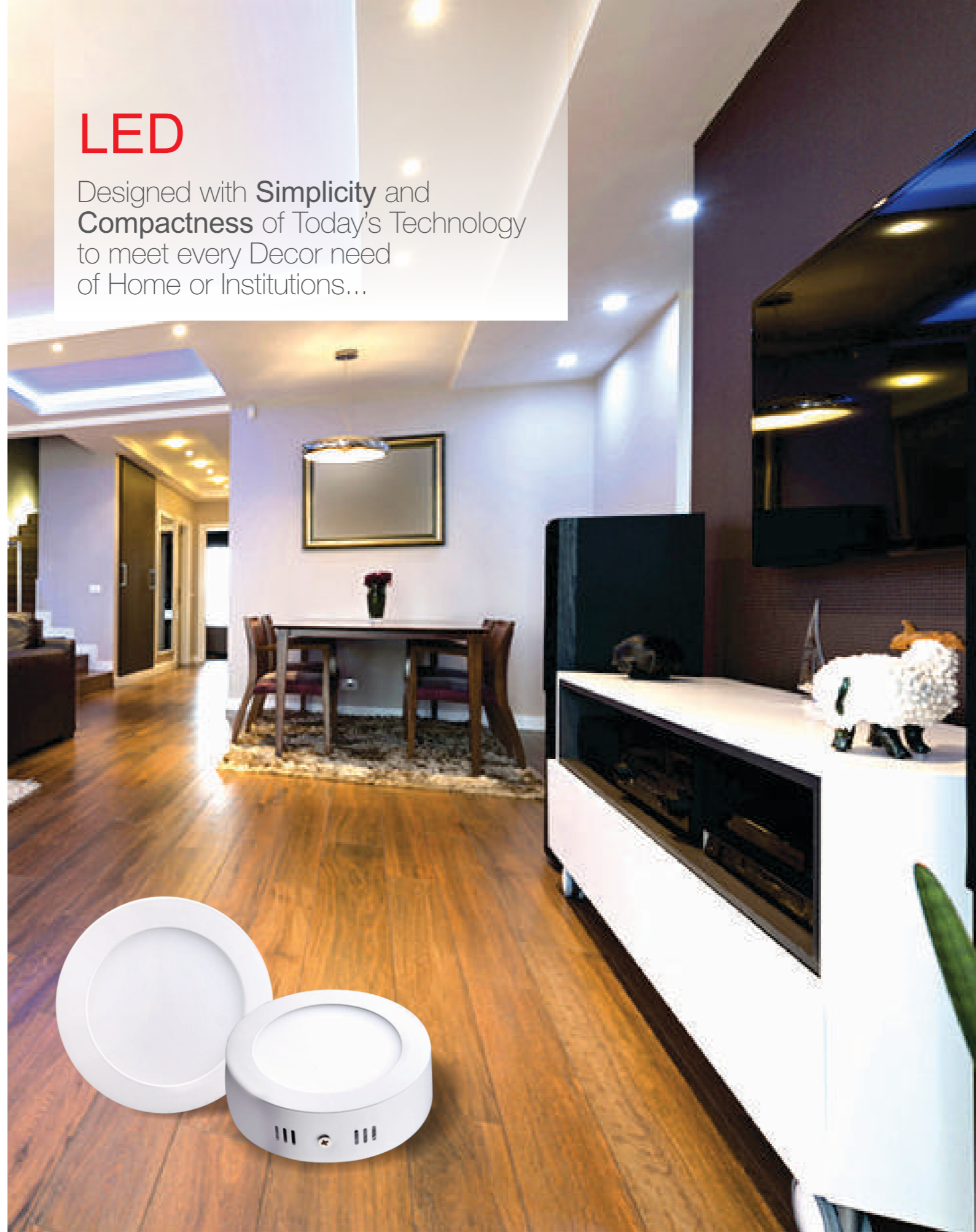

Impact & Scratch Protection\*



Long Life Technology



Special Coating Resists Oil\*



Eco Friendly



Anti Shatter\*



Energy Saving

# LED SLIM PANEL LIGHT



## Features

- LED slim recess panel with powder coated aluminium housing.
- Energy efficient LED technology with high efficacy and low power consumption.
- Replaceable external driver with on board circuit protection
- Cool source of light
- High quality panel light round & square wide range with colours.

SHAPE	POWER	SYSTEM LUMEN	CRI	CUT SIZE	OUTER SIZE
Round / Square	3Watt	240 lm	80	70 mm	85 mm
Round / Square	6Watt	480 lm	80	106 mm	120 mm
Round / Square	12Watt	1060 lm	80	156 mm	170 mm
Round / Square	18Watt	1520 lm	80	206 mm	225 mm

CCT : 3000K / 4000K / 6500K      IP : 20  
 Input Voltage : 100-285V      Beam Angle : 120°  
 PF : >0.9 / 0.5      Housing : Aluminium



Impact & Scratch Protection\*



Long Life Technology



Special Coating Resists Oil\*



Eco Friendly



Anti Shatter\*



Energy Saving

# LED SURFACE PANEL LIGHT



## Features

- LED slim recess panel with powder coated aluminium housing.
- Energy efficient LED technology with high efficacy and low power consumption.
- Replaceable external driver with on board circuit protection
- Cool source of light
- High quality panel light round & square wide range with colours.

SHAPE	POWER	SYSTEM LUMEN	CRI	OUTER SIZE	HEIGHT
Round / Square	3Watt	240 lm	80	85 mm	35 mm
Round / Square	6Watt	480 lm	80	120 mm	35 mm
Round / Square	12Watt	1060 lm	80	170 mm	35 mm
Round / Square	18Watt	1520 lm	80	225 mm	35 mm

CCT : 3000K / 4000K / 6500K

IP : 20

Input Voltage : 100-285V

Beam Angle : 120°

PF : >0.9 / 0.5

Housing : Aluminium



Impact & Scratch Protection\*



Long Life Technology



Special Coating Resists Oil\*



Eco Friendly



Anti Shatter\*



Energy Saving

# JUNCTION BOX LIGHTING

POT TYPE



## Features

- Elegant design with Ultra Slim Construction.
- Energy efficient LED technology with high efficacy and low power consumption.
- Anti-glare and frosted diffuser for even light distribution.
- Cool source of light.
- High brightness and illumination.
- Easy installation.
- Highly durable with long life of LED - up to 35000 burning hours.

SHAPE	POWER	SYSTEM LUMEN	CRI	CUT SIZE	OUTER SIZE
Round	6Watt	240 lm	80	80 mm	110 mm

Standard colour :



Input Voltage : 220-240V

PF : >0.9 / 0.5

IP : 20

Beam Angle : 120°

Housing : Plastic



Impact & Scratch Protection\*



Long Life Technology



Special Coating Resists Oil\*



Eco Friendly



Anti Shatter\*



Energy Saving

# JUNCTION BOX LIGHTING

## DOWNLIGHT



## Features

- Elegant design with Ultra Slim Construction.
- Energy efficient LED technology with high efficacy and low power consumption.
- Anti-glare and frosted diffuser for even light distribution.
- Cool source of light.
- High brightness and illumination.
- Easy installation.
- Highly durable with long life of LED - up to 35000 burning hours.

SHAPE	POWER	SYSTEM LUMEN	CRI	CUT SIZE	OUTER SIZE
Round	6Watt	240 lm	80	70 mm	110 mm

Standard colour :



Input Voltage : 220-240V

PF : >0.9 / 0.5

IP : 20

Beam Angle : 120°

Housing : Plastic



Impact & Scratch Protection\*



Long Life Technology



Special Coating Resists Oil\*



Eco Friendly



Anti Shatter\*



Energy Saving

# COB SPOT LED LIGHT



## Features

- COB Technology based downlight for better optics & CRI.
- Adjustable focus light for better lumen.
- Replaceable external driver with on board circuit protection.
- High grade aluminium heatsink for better heat dissipation.
- Cool source of light.

SHAPE	POWER	SYSTEM LUMEN	CUT SIZE	OUTER SIZE	HEIGHT
Round	3Watt	270 lm	54 mm	68 mm	37 mm
Round	6Watt	540 lm	70 mm	85 mm	56 mm
Round	10Watt	920 lm	70 mm	85 mm	72 mm
Round	16Watt	1440 lm	95 mm	110 mm	86 mm
Round	24Watt	2160 lm	116 mm	139 mm	95 mm
Round	30Watt	2700 lm	138 mm	160 mm	96 mm
Round	50Watt	2500 lm	138 mm	160 mm	125 mm

CCT : 3000K / 4000K / 6500K

Input Voltage : 100-285V

PF : >0.9 / 0.5

IP : 20

Beam Angle : 120°

Housing : Aluminium



Impact & Scratch Protection\*



Long Life Technology



Special Coating Resists Oil\*



Eco Friendly



Anti Shatter\*



Energy Saving

# LED TUBE LIGHT BATTEN

## T5 / T8



### Features

- Aluminium housing with high efficient SMD LED & low power consumption technology.
- Directional light source-improved light levels in work area.
- Soft glare free light.
- Aesthetic END caps to increase looks.
- High brightness and illumination.

	POWER	SYSTEM LUMEN	SIZE	CRI	HEIGHT
T5	3Watt	240 lm	590x20mm	80	30 mm
	6Watt	480 lm	1195x20mm	80	30 mm
T8	12Watt	1060 lm	595x30mm	80	35 mm
	18Watt	1520 lm	1205x30mm	80	35 mm

CCT : 3000K / 4000K / 6500K

Input Voltage : 100-285V

PF : >0.9 / 0.5

IP : 20

Beam Angle : 120°

Housing : Aluminium



Impact & Scratch Protection\*



Long Life Technology



Special Coating Resists Oil\*



Eco Friendly



Anti Shatter\*



Energy Saving



# LED FLOOD LIGHT



## Features

- LED Flood light aesthetically design with high grade pressure diecast aluminium housing.
- Surge protection upto 6KV and THD < 10%.
- IP65 Protection.
- Isolated electronics driver with inbuilt protection.

SHAPE	POWER	SYSTEM LUMEN	OUTER SIZE	HEIGHT
Square	10Watt	900 lm	118x125 mm	42 mm
Square	30Watt	2700 lm	225x220 mm	55 mm
Square	50Watt	4500 lm	282x272 mm	60 mm
Square	100Watt	9000 lm	287x287 mm	84 mm
Square	150Watt	12000 lm	314x334 mm	90 mm
Square	200Watt	16000 lm	375x375 mm	112 mm

CCT : 6500K

IP : 20

Input Voltage : 100-285V

Beam Angle : 120°

PF : >0.9 / 0.5

Housing : Aluminium



Impact & Scratch Protection\*



Long Life Technology



Special Coating Resists Oil\*



Eco Friendly



Anti Shatter\*



Energy Saving

# WIRES



## Features

- Heat resistant flame retardant.
- PVC insulated industrial grade cable.

### PRITAM SINGLE CORE, UNSHEATHED CABLES IN VOLTAGE GRADE 1100 VOLTS

Nominal area of Conductor (sq. mm)	Number Dia of wire (mm)	Thickness of Insulation (mm)	Approx. overall Dimeter (mm)	Current Carrying Capacity # 2 Cables, Single Phase		Resistance (max.) per km @ 20oC ohms.
				In Conduit Trunking Amps.	Un-enclosed Clipped Directly to a Surface or on Cable Tray Amps.	
0.75	24/.2**	0.6	2.3	6	7	26.0
1.0	14/.3*	0.7	2.8	11	12	18.10
1.5	22/.3*	0.7	3.1	13	16	12.10
2.5	36/.3*	0.8	3.8	18	22	7.41
4.0	56/.3**	0.8	4.4	24	29	4.95
6.0	84/.3**	0.8	4.9	31	37	3.30

Standard colour :



- Supplied in 90 meter lengths in attractive carton. Confirm to IS-694-2010. ISI Licence No. CM/L-8549494
- # As per IS3961(Part V)- 1968
- \* As per conductor class 2 of IS:8130/2013
- \*\* As per conductor class 5 of IS:8130/2013
- For BIS certification : Detail see website at <http://www.bis.org.in>



# MCBs

SCREW MOUNTING



## Features

- Un : 240 V~, 50Hz
- Breaking Capacity : 3kA

MCB	AMP	PACKAGING
Single Pole	6, 10, 16, 20, 25, 32	12
Double Pole	6, 10, 16, 20, 25, 32	6

ISOLATOR	AMP	PACKAGING
Double Pole	40	6

- Breaking Capacity 3000A
- Low watt loss
- IP-20 protection
- Protection against over-load and short-circuit.
- Use for per point protection.



# MCBs ISOLATOR CHANGEOVER

CHANNEL TYPE



## Features

- Un : 240 V~, 50Hz
- Breaking Capacity : 10kA

MCB	AMP	PACKAGING
Single Pole	6, 10, 16, 20, 25, 32	12
Double Pole	6, 10, 16, 20, 25, 32, 36, 40, 63	6
Triple Pole	6, 10, 16, 20, 25, 32, 36, 40, 63	4
Four Pole	6, 10, 16, 20, 25, 32, 36, 40, 63	3

ISOLATOR	AMP	PACKAGING
Double Pole	40	6

ISOLATOR	AMP	PACKAGING
Double Pole	40	6

- Breaking Capacity 10000A
- Low watt loss
- IP-20 protection
- Protection against over-load and short-circuit.
- Use for per point protection.





# Switches & Accessories



6 AMP 2PIN TOP & MALE FEMALE	PKG.
PRITAM 2 Pin Top	20
PRITAM Male Female	20
PC 2 Pin Top	20
PC Male Female	20
BLADE 2 Pin Top (PRITAM PLUS)	20
BLADE Male Female (PRITAM PLUS)	20



3 PIN TOP	PKG.
PRITAM 6 Amp 3 Pin Top	20
PRITAM 16 Amp 3 Pin Top	20
STONE 6 Amp 3 Pin Top (PRITAM PLUS)	20
STONE 16 Amp 3 Pin Top (PRITAM PLUS)	20
PRITAM PC 5 Amp 3 Pin Top	20
PRITAM PC 15 Amp 3 Pin Top	20



6 & 16 AMP. MULTI PLUG	PKG.
PRITAM 2 Pin Multi Plug	10
PRITAM 2-in-One Multi Plug	10
PRITAM 3 Pin 16 & 6Amp. Multi Plug	10
OMEGA INTERNATIONAL Multi Plug (PRITAM PLUS)	10



BED SWITCH AND PUSH	PKG.
PRITAM Bed Switch	20
PRITAM Bed Push	20
PRITAM Box Switch	10
PRITAM Box Push	10
PEBBLE Bed Switch (PRITAM PLUS)	20
PEBBLE BELL PUSH (PRITAM PLUS)	20

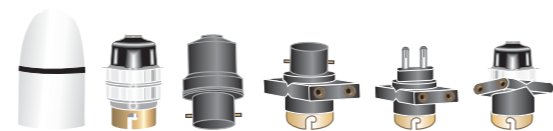

BED SWITCH AND PUSH	PKG.
PENDENT Holder	20
PENDENT Holder (Ring)	20
Single Adapter	30
Parallel Adapter	20
Pin Parallel Adapter	20
PENDENT Parallel Adapter	20

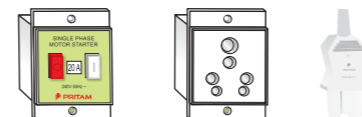

MOTOR STARTER, UNIVERSAL SOCKET & IRON CONNECTOR	PKG.
PRITAM Motor Starter (16/20/25 Amp)	10
PRITAM 6 & 16 Amp. Universal Socket	10
HERO Iron Connector	10

# Switches & Accessories

TESTER	PKG.
VIP	10
Greeno	10
SAATHI	10
Double Light	10
JYOTI (Industrial)	10

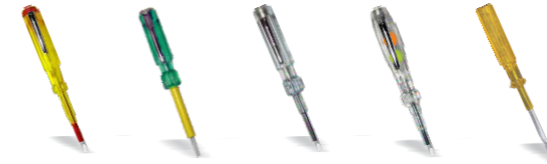

ACCESSORIES	PKG.
Starter PRITAM	20
Starter PERGO	30
Electronic Choke	10
Rotar Holder	20
Starter Seat	100
Capasitor (2.25 & 2.50)	50
Insulation Tape (Five Colours)	30



SPIKE GUARD / POWER STRIP / FLEX BOX	PKG.
1+4 Spike Guard	5
4+4 Spike Guard	5
Flex Box (2 Pin)	5



	PKG.
BUZZER	10
DING DONG	5
PIANO MUSICAL BELL	5
OVAL MUSICAL BELL	5



### AVAILABLE TONES IN MUSICAL BELL

- BUL BUL • MUSICAL DING DONG • MUSICAL BIRD
- PLEASE OPEN THE DOOR (POD) • GAYATRI MANTRA
- KRIPA DORJA KHULUN (KDK) • MULTI TUNE • OM NAMAH SHIVAY
- SALAM WALEKUM • AZAAN • AARTI • CHURCH



PUSH FIT JOINTS & CASING/ CAPING & ENCLOSURE	PKG.
3 X 3 Square Box	50
1" Internal	100
1" External	100
1" Elbow	100
1" Tee	100
3/4" Internal	100
3/4" External	100
3/4" Elbow	100
3/4" Tee	100
1 X 2 MCB (Plastic Encloser)	20
3 X 4 MCB (Plastic Encloser)	10
Plastic Enclosure (SM-2 & SM-4)	10
Junction Box (5 in One & SS Combined)	10
Foot Light LED 4M (FOOTSEE)	10

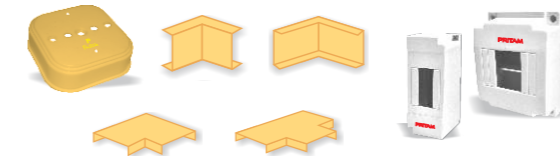

# Switchgear Systems



MAIN SWITCH	PKG.
16 Amp~ 240 V S.P.N.	1
16 Amp~ 240 V S.P.N. (JUMBO)	1
32 Amp~ 240 V D.P.	1
32 Amp~ 240 V D.P. (JUMBO)	1
32 Amp~ 240 V D.P. (NEW - HEAVY DUTY)	1
32 Amp~ 415 V T.P.N.	1
63 Amp~ 415 V D.P.	1
63 Amp~ 415 V T.P.N.	1
100 Amp~ 415 V T.P.N.	1
200 Amp~ 415 V T.P.N.	1

REVERSING / CHANGE OVERS	PKG.
16 Amp. Reversing Switch	1
32 Amp~ D.P. Change Over (Rev, Type)	1
32 Amp~ T.P. Change Over (Rev, Type)	1
Open Change Over	1
16 Amp~ 240 V D.P. Change Over	1
32 Amp~ 240 V D.P. Change Over	1
32 Amp~ 415 V F.P. Change Over	1
63 Amp~ 415 V D.P. Change Over	1
63 Amp~ 415 V F.P. Change Over	1
100 Amp~ 415 V F.P. Change Over	1
200 Amp~ 415 V F.P. Change Over	1

BUSBAR CHAMBER	PKG.
32 Amp~ 415 V	1
63 Amp~ 415 V	1
100 Amp~ 415 V	1
200 Amp~ 415 V	1
200 Amp~ 415 V (With Fuse)	1

FUSE UNIT (COPPER U)	PKG.
16 Amp~ 240 V	12
32 Amp~ 415 V	6
63 Amp~ 415 V	3
100 Amp~ 415 V	1
200 Amp~ 415 V	1



# Distribution Boxes

ECO BOX	PKG.
2 Way Single Door	1
4 Way Single Door	1
6 Way Single Door	1
8 Way Single Door	1
12 Way Single Door	1
16 Way Single Door	1
4 Way Double Door	1
6 Way Double Door	1
8 Way Double Door	1
12 Way Double Door	1
16 Way Double Door	1
4 Way Double Door TPN	1
6 Way Double Door TPN	1
8 Way Double Door TPN	1



PRO BOX	PKG.
2 Way Single Door	1
4 Way Single Door	1
6 Way Single Door	1
8 Way Single Door	1
12 Way Single Door	1
16 Way Single Door	1
6 Way Double Door	1
8 Way Double Door	1
12 Way Double Door	1
16 Way Double Door	1
4 Way Double Door TPN	1
6 Way Double Door TPN	1
8 Way Double Door TPN	1
4 Pole Enclosure (Cutout)	1



D-BOARD	PKG.
6 Way Double Door	1
8 Way Double Door	1
12 Way Double Door	1
16 Way Double Door	1





[www.pritamworld.com](http://www.pritamworld.com)  
Email : [info@pritamworld.com](mailto:info@pritamworld.com)

 *A Babli Bhai Creation*®

Follow us on



Authorised dealer/Channel Partner

